



Caracalla



Caracalla



GRES PORCELLANATO
SMALTATO

DIGITAL
TECHNOLOGY

La bellezza eterna e il moderno design

Pietre naturali, ognuna diversa
naturali, lappate, rettificate,
impresiosite di mosaici
per ambientazioni esclusive.
Stile italiano inimitabile di Vallelunga.

The timeless beauty and modern design

Natural stones, each one different
natural, semipolished, rectified
made precious with mosaics
for exclusive environments
Vallelunga Italian inimitable style

Божественная красота и современный дизайн

Природный камень, каждый уникален по-своему
натуральный, лапатированный, ректифицированный,
украшен мозаикой
для эксклюзивного интерьера.
Единственный и неповторимый стиль Валлелунги.



AVORIO



AVORIO



AVORIO



AVORIO



GRIGIO



GRIGIO





GRIGIO



GRIGIO



SABBIA



SABBIA



SABBIA



SABBIA



AVORIO

GRIGIO

SABBIA



G103SM AVORIO MURETTO 15
30x30 - 12"x12"

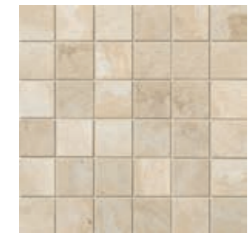

G100SM AVORIO MOSAICO 15
TESSERE 5x5
30x30 - 12"x12"

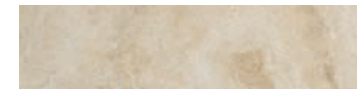

G2000A CARACALLA AVORIO LAPP. RETT. 68
11x45 - 4,4"x17,7"

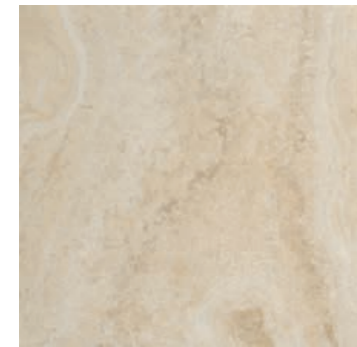

G103FL CARACALLA AVORIO LAPP. RETT. 65
45x45 - 17,7"x17,7"



G100FL CARACALLA AVORIO LAPP. RETT. 67
45x90 - 17,7"x35,5"

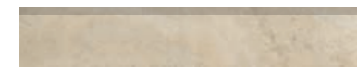

G10002 AVORIO BATTISCOPIA LAPP. RETT. 12
8x45 - 3,1"x17,7"



G104SM GRIGIO MURETTO 15
30x30 - 12"x12"



G101SM GRIGIO MOSAICO 15
TESSERE 5x5
30x30 - 12"x12"

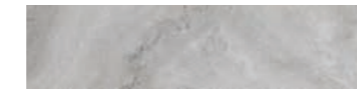

G2014A CARACALLA GRIGIO LAPP. RETT. 68
11x45 - 4,4"x17,7"

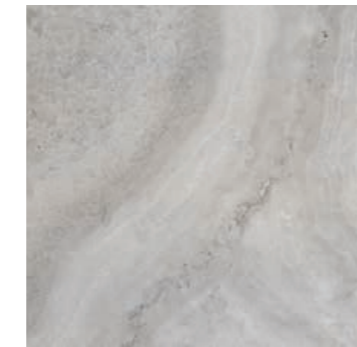

G104FL CARACALLA GRIGIO LAPP. RETT. 65
45x45 - 17,7"x17,7"

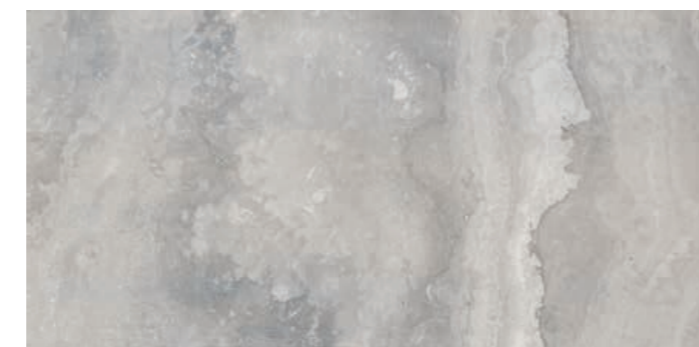

G101FL CARACALLA GRIGIO LAPP. RETT. 67
45x90 - 17,7"x35,5"

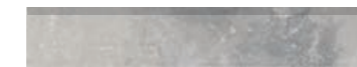

G10003 GRIGIO BATTISCOPIA LAPP. RETT. 12
8x45 - 3,1"x17,7"



G105SM SABBIA MURETTO 15
30x30 - 12"x12"

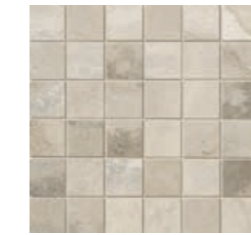

G102SM SABBIA MOSAICO 15
TESSERE 5x5
30x30 - 12"x12"



G2015A CARACALLA SABBIA LAPP. RETT. 68
11x45 - 4,4"x17,7"



G105FL CARACALLA SABBIA LAPP. RETT. 65
45x45 - 17,7"x17,7"

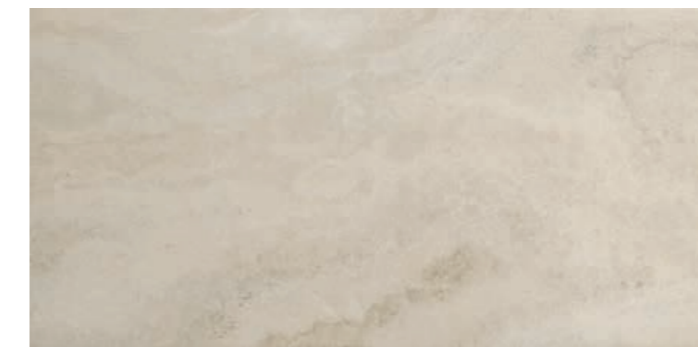

G102FL CARACALLA SABBIA LAPP. RETT. 67
45x90 - 17,7"x35,5"

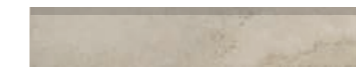

G10001 SABBIA BATTISCOPIA LAPP. RETT. 12
8x45 - 3,1"x17,7"

G30803 ANG. 6
BACCHETTA ALLUMINIO
1,5x1,5 - 0,6"x0,6"

G30801 BACCHETTA ALLUMINIO 19
1,5x90 - 0,6"x35,5"

G30804 ANG. 6
BACCHETTA CROMO
1,5x1,5 - 0,6"x0,6"

G30802 BACCHETTA CROMO 19
1,5x90 - 0,6"x35,5"

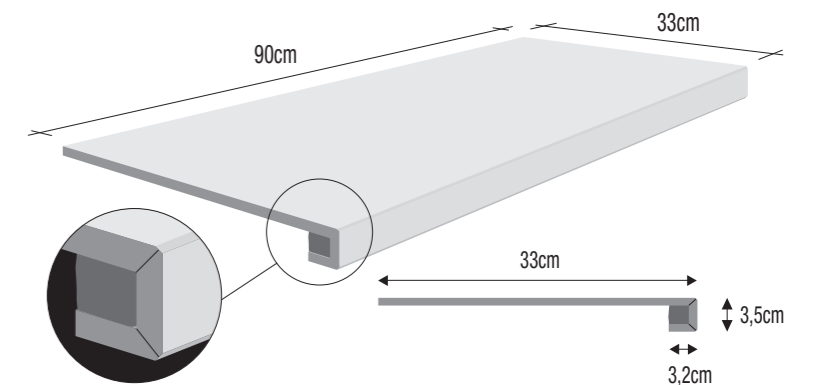

GRADONE 33x90 13"x35,5"

Gradone disponibile per ogni colore della serie su richiesta.
Gradone available upon request for each color of the collection.

Caracalla

Imballaggi - packing - emballages - verpackung - Упаковки

Formato Size cm Format cm Format cm Формат см	Pezzi/scatola Pieces/box Pièces/boîte Stück/Karton Изделий/коробку	Mq/scatola Sq.Mt./box Mq/boîte Qm/Karton M2/коробку	Kg/scatola Weight/box Poids/boîte Gewichte/Karton Kг/коробку	Scatole/pallet Box/pallet Boîte/pallet Karton/pallet Коробок/паллеты	Mq/pallet Sq.Mt./pallet Mq/pallet Qm/pallet M2/паллеты	Kg/pallet Weight/pallet Poids/pallet Gewichte/pallet Kг/паллеты	Scatole/europallet Box/europallet Boîte/europallet Karton/europallet Коробки/Евролотки	Mq/europallet Sq.Mt./europallet Mq/europallet Qm/europallet M2/Евролотки	Kg/europallet Weight/europallet Poids/europallet Gewichte/europallet Kг/ Евролотки	Spessore Thickness Epaisseur Stärke Толщина
45x90 Fondo	3	1,22	29,25	32	39,04	957,7	-	-	-	10
45x45 Fondo	6	1,22	23,60	26	31,72	635,3	-	-	-	10
11x45 Fondo	14	0,69	13,35	44	30,36	609,10	-	-	-	10
30x30 Muretto	6	-	-	-	-	-	-	-	-	
30x30 Mosaico	9	-	17,47	-	-	-	-	-	-	
8x45 Battiscopa	20	-	14,5	-	-	-	-	-	-	

CARATTERISTICHE TECNICHE Technical Characteristics / Caracteristiques Techniques / Technische Eigenschaften CONFORME / ACCORDING TO / CONFORME / GEMÄß ANSI 137.1 Impervious porcelain tiles				
VALLELUNGA SMALTA TECNOLOGY	CARATTERISTICHE TECNICHE TECHNICAL CHARACTERISTICS CARACTERISTIQUES TECHNIQUES TECHNISCHE EIGENSCHAFTEN	METODO DI PROVA ASTM TEST METHOD ASTM METHODE D'ESSAI ASTM PRÜFMETHODE ASTM	REQUISITI PRESCRITTI Required Value Valeur Requise Vorgeschriebener Wert ANSI 137.1	VALORI Value/Value/Wert VALLELUNGA SMALTA GLAZED GL
	ASSORBIMENTO D'ACQUA WATER ABSORPTION ABSORPTION D'EAU WASSERABSORPTION	EN-ISO 10545-3	0,5% (fully vitrified)	≤ 0,05
	RESISTENZA ALLA ROTTURA BREAKING MODULUS RÉSISTANCE À LA FLEXION BIEGEFESTIGKEIT	EN-ISO 10545-4	≥250 Pounds ≥113 Kg ≥1110 N	CONFORME Compliant
	DUREZZA MOHS MOHS HARDNESS DURETÉ MOHS HÄRTE MOHS	EN-ISO 101		MOHS 5
	RESISTENZA ALL'ABRASIONE ABRASION RESISTANCE RÉSISTANCE À L'ABRASION ABRASIONSWIDERSTÄNDIGKEIT	EN-ISO 10545-7	NON RICHIESTO Not required	METODO DI PROVA ISO 10545-7 PEI IV
	RESISTENZA AGLI SBALZI TERMICI THERMAL SHOCK RESISTANCE RÉSISTANCE AUX CHOC THERMIQUES TEMPERATURWECHSELBESTÄNDIGKEIT	ASTM C484	RICHIESTO required	RESISTENTE Resistant
	RESISTENZA ALL'ATTACCO CHIMICO CHEMICAL RESISTANCE RÉSISTANCE CHIMIQUE CHEMISCHE BESTÄNDIGKEIT	EN-ISO 10545-13	NON RICHIESTO Not required	RESISTENTE Resistant
	RESISTENZA AL GELO FROST RESISTANCE RÉSISTANCE AU GEL FROSTBESTÄNDIGKEIT	EN-ISO 10545-12	NON RICHIESTO Not required	RESISTENTE Resistant
	RESISTENZA ALLE MACCHIE STAIN RESISTANCE RÉSISTANCE AUX TACHES FLECKENBESTÄNDIGKEIT	EN-ISO 10545-14	NON RICHIESTO Not required	RESISTENTE Resistant
	SPESORE THICKNESS ÉPAISSEUR STÄRKE	ASTM C485 Planarit Warpage	≤ 1,0% Sui lati/On sides ≤ 0,75% Sulle diagonali/On diagonals	CONFORME Compliant
		ASTM C499 Dimensioni Dimensions	≤ 3,0% Sulle dimensioni nominali Of nominal dimensions ≤ 1,5% Differenza nel lotto tra valori min. e max./Difference in batch between min. and major values.	CONFORME Compliant
		ASTM C499 Spessore Thickness	≤ 0,040 inch Differenza nel lotto tra spessore min. e max. Difference in batch between min. and major thickness	CONFORME Compliant
		ASTM C502 Parallelismo dei lati Wedging	≤ 1,0 %	CONFORME Compliant

**AMOUNT OF
COLOUR
VARIATION**

**V3
HIGH
COLOR
VARIATION**

Ceramica Vallelunga Inc. is committed to the environment's respect and designs its products so that they can be eco-friendly and meet the needs of environmental sustainability. Particularly, CARACALLA tiles are characterized by a number of pre-consumer recycled content of 17.5%



01036 NEPI (VT) Loc. Settevene Via dell'Industria n, 7 Tel. 0761 5291 - 4 linee - Fax. 0761 527156
www.vallelungacer.it - www.vallelungaceramica.ru